



Marshall Best Security Corporation



Anti-Ligature Knob ANSI Grade 1 Mortise Lockset-MRX-K

Specifications:

- High quality Stainless steel components
- Meets or exceeds all performance testing of ANSI A156.13 Grade 1 mortise locks
- Integral part of your Health/Safety and Accident Prevention programs
- Mortise is UL listed for a 3 hour fire door
- Variety of mortise functions available to fit your unique security and safety requirements
- Heavy duty escutcheon and sectional trim available
- Non-Handed field reversible

Code Compliance



ANSI A-156.13-2005
ADA Barrier-Free Accessibility

HOW TO ORDER – MRX-K MORTISE LOCKS

<u>Series</u>	<u>Function</u>	<u>Trim</u>	<u>Finish</u>	<u>Hand</u>
MRX-E	Escutcheon Per	K – Knob	630	As Req'd.
MRX-S	Sectional	Chart		

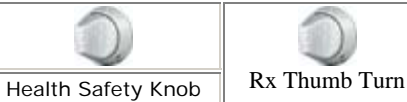
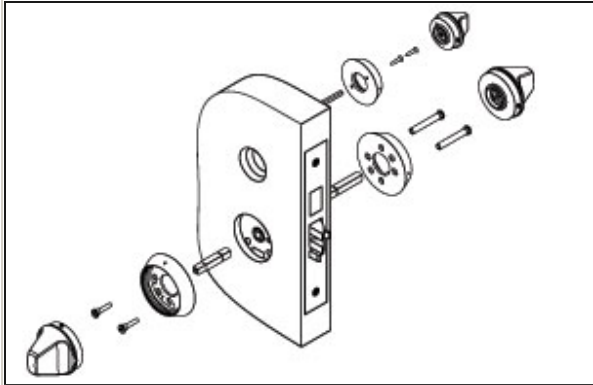

Available Knobs



Available Finishes

<u>F-01</u>	<u>F-04</u>	<u>F-05</u>	<u>F-07</u>	<u>F-13</u>	<u>F-20</u>
-------------	-------------	-------------	-------------	-------------	-------------







(other functions available upon request)







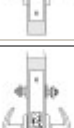

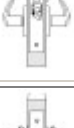
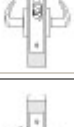
Available Functions



Marshall Best Security Corporation
13097 Parkside Drive
Fishers, IN 46051

Phone: 317-806-1180
Fax: 317-578-2904

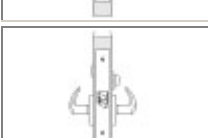
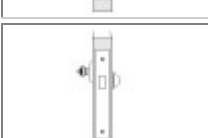
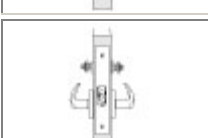
Mortise Locks

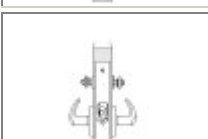
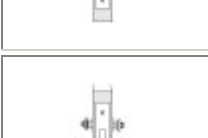
ANSI No.	Series/Function	Type	Outside	Inside	Function Description
F01	MRX-K-01	Passage or Closet			Latchbolt operated by lever from either side at all times.
F04	MRX-K-04	Entry/Office			Latchbolt operated by lever from either side except when outside lever is made inoperative by push button rocker. When outside lever is locked, latchbolt may be retracted by key from outside or by rotating inside lever. *** Auxiliary deadbolt latch.
F05	MRX-K-05	Classroom			Latchbolt operated by lever from either except when outside lever is locked from outside by key. When outside lever is locked, latched may be retracted by inside lever, or outside lever, when cylinder is unlocked by key. *** Auxiliary deadbolt latch.
F06	MRX-K-06	Holdback			Latch bolt operated by lever either side, except when outside lever is locked from outside by key. Latch bolt can be locked in a retracted position by key. When outside lever is locked, latch bolt is retracted by key from outside or by operating inside lever unless latch bolt has been locked in a retracted position. ***Auxiliary latch deadlocks latch bolt.
F07	MRX-K-07	Storeroom or Closet			Latchbolt operated by key from outside or by rotating inside lever. Outside lever is always inoperative. *** Auxiliary deadbolt latch.
F09	MRX-K-09	Apartment / Exit or Public Toilet			Latch bolt operated by lever from either side, except when outside lever is locked by key from inside. When outside lever is locked, latch bolt is retracted by key from outside or by operating inside lever. ****Auxiliary dead bolt latch
F12	MRX-K-12	Dormitory or Exit			Latch bolt operated by lever from either side, except when outside lever is made inoperative by a stop or mechanical means other than key. Dead bolt projected by key from outside and by turn from inside. Deadbolt retracted by key from outside and by turn from inside. Operating inside lever retracts both bolts and outside remains locked.
F13	MRX-K-13	Dormitory or Exit			Latchbolt operated by lever from either side. Deadbolt projected by key from outside and thumbturn from inside. Rotating inside lever retracts both bolts (simultaneous retraction). Extended deadbolt automatically deadlocks latchbolt.
F14	MRX-K-14	Storeroom			Latchbolt operated by lever from either side. Deadbolt by key on either side.
F15	MRX-K-15	Hotel or Motel			Latchbolt operated by key from outside or by rotating inside lever. Outside lever is always inoperative. Deadbolt operated by thumbturn from inside which shuts out all keys except emergency key. Inside lever will retract both bolts (simultaneous retraction). *** Auxiliary deadbolt latch.

F16	MRX-K-16	Deadlock		Deadbolt by key on either side.
F17	MRX-K-17	Deadlock		Deadbolt by key outside and turnpiece inside
F18	MRX-K-18	Deadlock		Deadbolt by key one side only.
F02 F19	MRX-K-02 19	Privacy or Bathroom		Latchbolt operated by lever from either side except when turnpiece projects deadbolt and locks outside lever. Unlocked by turning inside lever or by using emergency key which retracts the deadbolt.
F20	MRX-K-20	Entrance/ Apartment/ Dormitory		Latchbolt operated by lever from either side except when outside lever is made inoperative by push button rocker. Deadbolt projected by key from outside and by thumbturn from inside. Deadbolt retracted by key from outside. Both bolts retracted by inside lever (simultaneous retraction). *** Auxiliary deadbolt latch.
F21	MRX-K-21	Dormitory with Dead bolt		Latch bolt operated by lever either side. Dead bolt operated by key outside or by turn from inside.
F22	MRX-K-22	Privacy		Latch bolt operated by lever either side, except when outside lever is locked by inside turn. Operating inside lever, closing door or operating outside emergency release unlocks outside lever.
F29	MRX-K-29	Classroom Dead bolt (only)		Key from outside operates dead bolt. Turn from inside retracts but does not project dead bolt.
F30	MRX-K-30	Institution		Latch bolt operated by key either side. Both levers always inoperative. ***Auxiliary latch deadlocks latch bolt.
F31	MRX-K-31	Exit		Latch bolt operated by lever from inside. Non removable blank lever or no lever outside. ***Auxiliary latch deadlocks latch bolt.
F32	MRX-K-32	Intruder Latch bolt		Latch bolt operated by lever either side, except when outside lever is locked from inside or outside by key. When outside lever is locked, latch bolt is retracted by key from inside or outside or by operating inside lever. ***Auxiliary latch Deadlock latch bolt.
F33	MRX-K-33	Entrance/ Apartment/ Dormitory		Latchbolt operated by lever from either side except when outside lever is made inoperative by push button rocker. Deadbolt projected by key from outside and by thumbturn from inside. Deadbolt retracted by key from outside. Both bolts retracted by inside lever (simultaneous retraction). *** Auxiliary deadbolt latch.

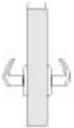
F34	MRX-K-34	Intruder Dead bolt		Latch bolt operated by lever either side, except when outside lever is locked from inside or outside by key. Dead bolt operated by key either side. Inside lever retracts both bolts and unlocks outside lever.
F35	MRX-K-35	Intruder Dead bolt		Latch bolt operated by lever either side, except when outside lever is locked from inside or outside by key. Dead bolt operated by key either side. Operating inside lever retracts both bolts and unlocks outside. *** Auxiliary dead latch or latch bolt dead locked when dead bolt is thrown.
F41	MRX-K-41	Single Dummy		No Lock works, Lever one side only.
F42	MRX-K-42	Double Dummy		No Lock works, Lever on both sides.

Marshall Best Security Corporation
13097 Parkside Drive
Fishers, IN 46051

Phone: 317-806-1180
Fax: 317-578-2904